

Plastic Medium Power Silicon NPN Transistor

... designed for use as audio amplifiers and drivers utilizing complementary or quasi complementary circuits.

- DC Current Gain — $h_{FE} = 40$ (Min) @ $I_C = 0.15$ Adc
- BD 165, 169 are complementary with BD 166, 168, 170

MAXIMUM RATINGS

Rating	Symbol	Type	Value	Unit
Collector–Emitter Voltage	V_{CEO}	BD 165	45	
		BD 169	80	
Collector–Base Voltage	V_{CBO}	BD 165	45	Vdc
		BD 169	80	
Emitter–Base Voltage	V_{EBO}		5	Vdc
Collector Current	I_C		1.5	Adc
Base Current	I_B		0.5	Adc
Total Device Dissipation @ $T_A = 25^\circ\text{C}$ Derate above 25°C	P_D		1.25	Watts mW/ $^\circ\text{C}$
			8	
Total Device Dissipation @ $T_C = 25^\circ\text{C}$ Derate above 25°C	P_D		20	Watt mW/ $^\circ\text{C}$
			160	
Operating and Storage Junction Temperature Range	T_J, T_{stg}		–65 to +150	$^\circ\text{C}$

THERMAL CHARACTERISTICS

Characteristic	Symbol	Max	Unit
Thermal Resistance, Junction to Case	θ_{JC}	6.25	$^\circ\text{C}/\text{W}$
Thermal Resistance, Junction to Ambient	θ_{JA}	100	$^\circ\text{C}/\text{W}$

ELECTRICAL CHARACTERISTICS ($T_C = 25^\circ\text{C}$ unless otherwise noted)

Characteristic	Symbol	Type	Min	Max	Unit
Collector–Emitter Sustaining Voltage* ($I_C = 0.1$ Adc, $I_B = 0$)	BV_{CEO}	BD 165	45	—	Vdc
		BD 169	80	—	
Collector Cutoff Current ($V_{CB} = 45$ Vdc, $I_E = 0$) ($V_{CB} = 80$ Vdc, $I_E = 0$)	I_{CBO}	BD 165	—	0.1	mA dc
		BD 169	—	0.1	
Emitter Cutoff Current ($V_{BE} = 5.0$ Vdc, $I_C = 0$)	I_{EBO}		—	1.0	mA dc
DC current Gain ($I_C = 0.15$ A, $V_{CE} = 2$ V) ($I_C = 0.5$ A, $V_{CE} = 2$ V)	h_{FE}^*		40	—	
			15	—	
Collector–Emitter Saturation Voltage* ($I_C = 0.5$ Adc, $I_B = 0.05$ Adc)	$V_{CE(sat)}^*$		—	0.5	Vdc
Base–Emitter On Voltage* ($I_C = 0.5$ Adc, $V_{CE} = 2.0$ Vdc)	$V_{BE(on)}^*$		—	0.95	Vdc
Current Gain–Bandwidth Product ($I_C = 500$ mA dc, $V_{CE} = 2$ Vdc, $f = 1.0$ MHz)	f_T		6.0	—	MHz

* Pulse Test: Pulse Width ≤ 300 μs , Duty Cycle $\leq 2.0\%$.

REV 7

BD165
BD169

1.5 AMPERE
POWER TRANSISTORS
NPN SILICON
45, 60, 80 VOLTS
20 WATTS

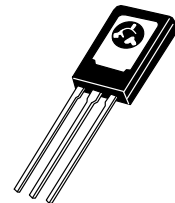

CASE 77–08
TO–225AA TYPE

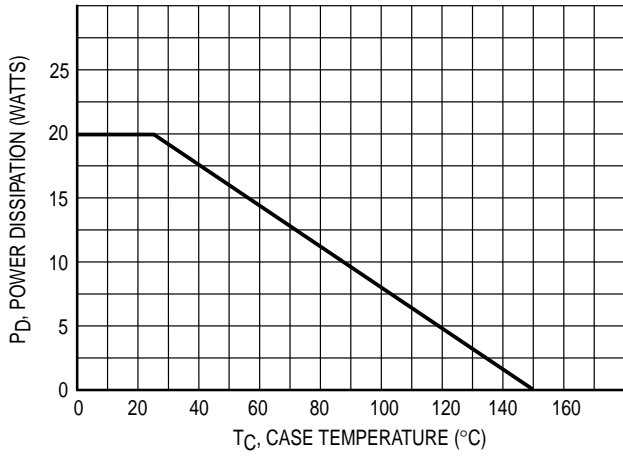

Figure 1. PD – TC Derating Curve

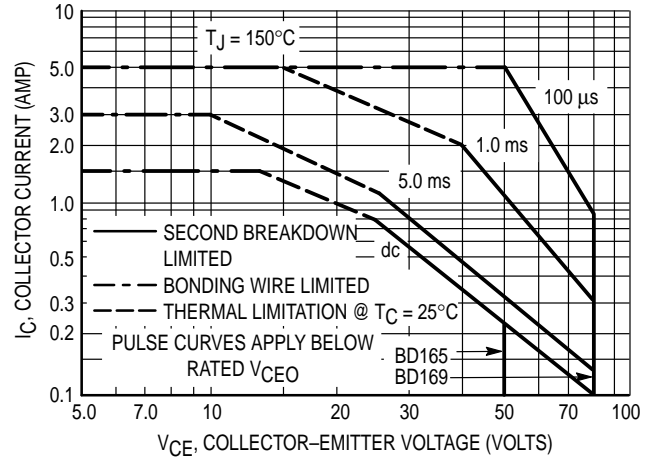

Figure 2. Safe Operating Area (see Note 1)

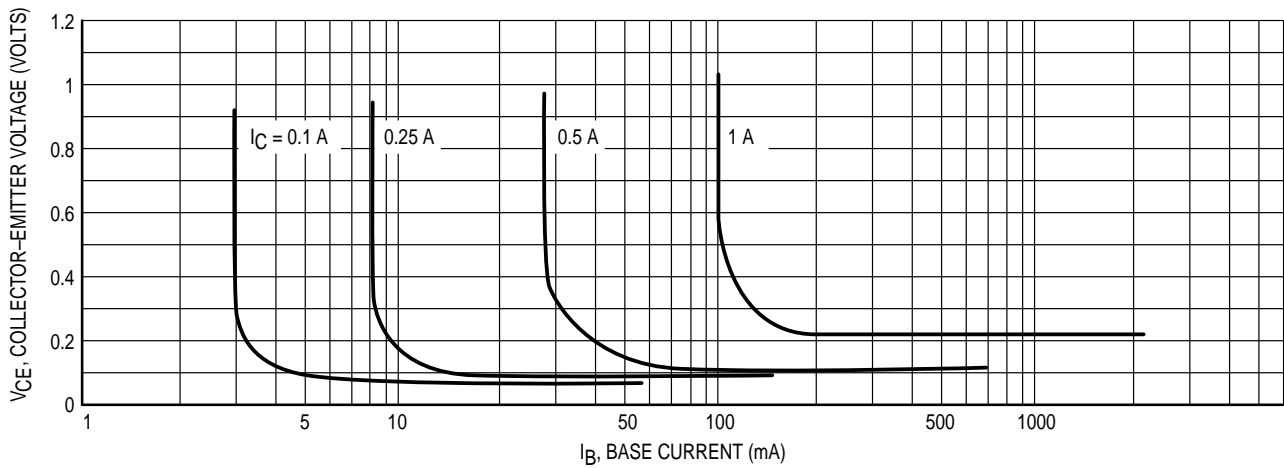

Figure 3. Collector Saturation Region

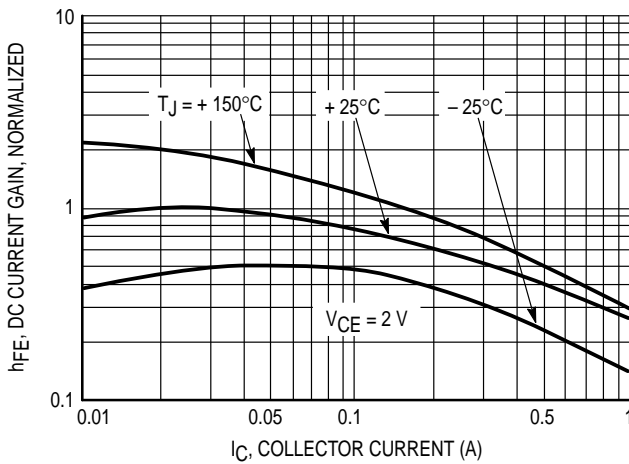

Figure 4. Current Gain

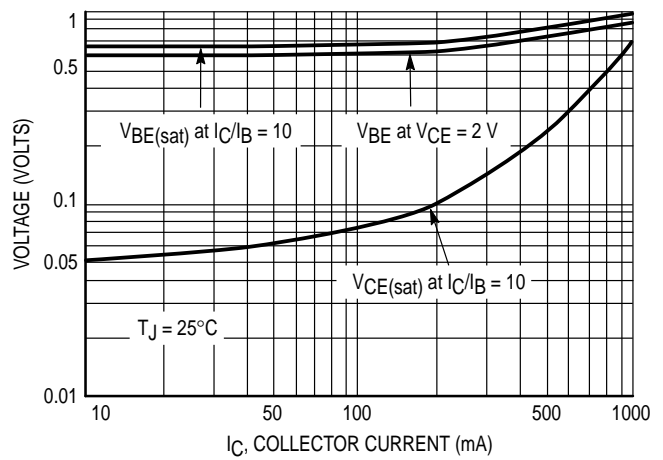

Figure 5. "On" Voltage

Note 1:

There are two limitations on the power handling ability of a transistor; average junction temperature and second breakdown. Safe operating area curves indicate $I_C - V_{CE}$ limits of the transistor that must be observed for reliable operation; i.e., the transistor must not be subjected to greater dissipation than the curves indicate.

The data of Figure 2 is based on $T_{J(pk)} = 150^\circ\text{C}$; T_C is variable depending on conditions. Second breakdown pulse limits are valid for duty cycles to 10% provided $T_{J(pk)} \leq 150^\circ\text{C}$. At high case temperatures, thermal limitations will reduce the power that can be handled to values less than the limitations imposed by second breakdown.

PACKAGE DIMENSIONS

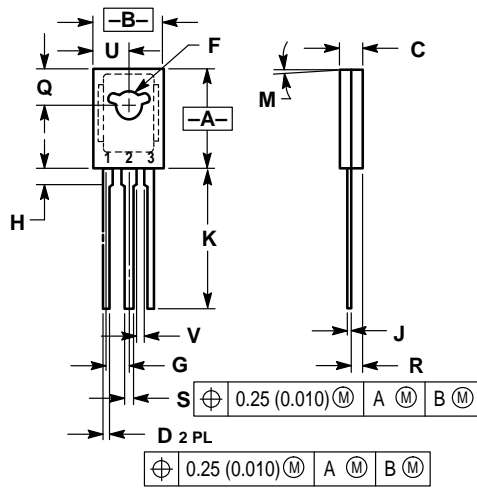

- NOTES:
 1. DIMENSIONING AND TOLERANCING PER ANSI Y14.5M, 1982.
 2. CONTROLLING DIMENSION: INCH.

DIM	INCHES		MILLIMETERS	
	MIN	MAX	MIN	MAX
A	0.425	0.435	10.80	11.04
B	0.295	0.305	7.50	7.74
C	0.095	0.105	2.42	2.66
D	0.020	0.026	0.51	0.66
F	0.115	0.130	2.93	3.30
G	0.094 BSC		2.39 BSC	
H	0.050	0.095	1.27	2.41
J	0.015	0.025	0.39	0.63
K	0.575	0.655	14.61	16.63
M	5° TYP		5° TYP	
Q	0.148	0.158	3.76	4.01
R	0.045	0.055	1.15	1.39
S	0.025	0.035	0.64	0.88
U	0.145	0.155	3.69	3.93
V	0.040	—	1.02	—

- STYLE 1:
 PIN 1. EMITTER
 2. COLLECTOR
 3. BASE

CASE 77-08
 TO-225AA TYPE
 ISSUE V

Motorola reserves the right to make changes without further notice to any products herein. Motorola makes no warranty, representation or guarantee regarding the suitability of its products for any particular purpose, nor does Motorola assume any liability arising out of the application or use of any product or circuit, and specifically disclaims any and all liability, including without limitation consequential or incidental damages. "Typical" parameters can and do vary in different applications. All operating parameters, including "Typicals" must be validated for each customer application by customer's technical experts. Motorola does not convey any license under its patent rights nor the rights of others. Motorola products are not designed, intended, or authorized for use as components in systems intended for surgical implant into the body, or other applications intended to support or sustain life, or for any other application in which the failure of the Motorola product could create a situation where personal injury or death may occur. Should Buyer purchase or use Motorola products for any such unintended or unauthorized application, Buyer shall indemnify and hold Motorola and its officers, employees, subsidiaries, affiliates, and distributors harmless against all claims, costs, damages, and expenses, and reasonable attorney fees arising out of, directly or indirectly, any claim of personal injury or death associated with such unintended or unauthorized use, even if such claim alleges that Motorola was negligent regarding the design or manufacture of the part. Motorola and  are registered trademarks of Motorola, Inc. Motorola, Inc. is an Equal Opportunity/Affirmative Action Employer.

How to reach us:

USA / EUROPE: Motorola Literature Distribution;
P.O. Box 20912; Phoenix, Arizona 85036. 1-800-441-2447

JAPAN: Nippon Motorola Ltd.; Tatsumi-SPD-JLDC, Toshikatsu Otsuki,
6F Seibu-Butsuryu-Center, 3-14-2 Tatsumi Koto-Ku, Tokyo 135, Japan. 03-3521-8315

MFAX: RMFAX0@email.sps.mot.com - TOUCHTONE (602) 244-6609
INTERNET: <http://Design-NET.com>

HONG KONG: Motorola Semiconductors H.K. Ltd.; 8B Tai Ping Industrial Park,
51 Ting Kok Road, Tai Po, N.T., Hong Kong. 852-26629298

