

## MF4 4th Order Switched Capacitor Butterworth Lowpass Filter

### General Description

The MF4 is a versatile, easy to use, precision 4th order Butterworth low-pass filter. Switched-capacitor techniques eliminate external component requirements and allow a clock-tunable cutoff frequency. The ratio of the clock frequency to the low-pass cutoff frequency is internally set to 50 to 1. A Schmitt trigger clock input stage allows two clocking options, either self-clocking (via an external resistor and capacitor) for stand-alone applications, or for tighter cutoff frequency control an external TTL or CMOS logic compatible clock can be applied. The maximally flat passband frequency response together with a DC gain of 1 V/V allows cascading MF4 sections together for higher order filtering.

### Features

- Low Cost
- Easy to use
- 8-pin mini-DIP or 14-pin wide-body S.O.
- No external components
- 5V to 14V supply voltage
- Cutoff frequency range of 0.1 Hz to 20 kHz
- Cutoff frequency accuracy of  $\pm 0.3\%$  typical
- Cutoff frequency set by external clock
- Separate TTL and CMOS/Schmitt-trigger clock inputs

### Connection Diagram

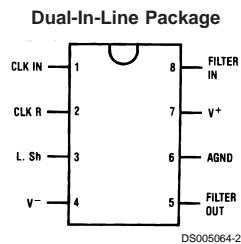

Order Number MF4CN-50  
See NS Package Number N08E

### Block Diagram

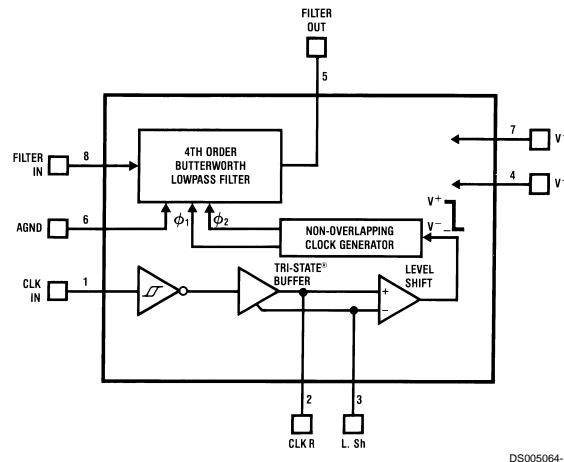

TRI-STATE® is a registered trademark of National Semiconductor Corp.

## Block Diagram (Continued)

### Pin Descriptions

Pin #	Pin Name	Function
1	CLK IN	A CMOS Schmitt-trigger input to be used with an external CMOS logic level clock. Also used for self clocking Schmitt-trigger oscillator (see section 1.1).
2	CLK R	A TTL logic level clock input when in split supply operation ( $\pm 2.5V$ to $\pm 7V$ ) with L. Sh tied to system ground. This pin becomes a low impedance output when L. Sh is tied to $V^-$ . Also used in conjunction with the CLK IN pin for a self clocking Schmitt-trigger oscillator (see section 1.1). The TTL input signal must not exceed the supply voltages by more than 0.2V.
3	L. Sh	Level shift pin; selects the logic threshold levels for the clock. When tied to $V^-$ it enables an internal tri-state buffer stage between the Schmitt trigger and the internal clock level shift stage thus enabling the CLK IN Schmitt-trigger input and making the CLK R pin a low impedance output. When the voltage level at this input exceeds 25% ( $V^+ - V^-$ ) + $V^-$ the internal tri-state buffer is disabled allowing the CLK R pin to become the clock input for the internal clock level-shift stage. The CLK R threshold level is now 2V above the voltage on the L. Sh pin. The CLK R pin will be compatible with TTL logic levels when the MF4 is operated on split supplies with the L. Sh pin connected to system ground.
5	FILTER OUT	The output of the low-pass filter. It will typically sink 0.9 mA and source 3 mA and swing to within 1V of each supply rail.
6	AGND	The analog ground pin. This pin sets the DC bias level for the filter section and must be tied to the system ground for split supply operation or to mid-supply for single supply operation (see section 1.2). When tied to mid-supply this pin should be well bypassed.
7, 4	$V^+$ , $V^-$	The positive and negative supply pins. The total power supply range is 5V to 14V. Decoupling these pins with 0.1 $\mu F$ capacitors is highly recommended.

Pin #	Pin Name	Function
8	FILTER IN	The input to the low-pass filter. To minimize gain errors the source impedance that drives this input should be less than 2K (see section 1.3 of the Application Hints). For single supply operation the input signal must be biased to mid-supply or AC coupled through a capacitor.

## Absolute Maximum Ratings (Notes 1, 2)

If Military/Aerospace specified devices are required, please contact the National Semiconductor Sales Office/Distributors for availability and specifications.

Supply Voltage (V <sup>+</sup> -V <sup>-</sup> )	14V
Voltage At Any Pin	V <sup>+</sup> + 0.2V V <sup>-</sup> - 0.2V
Input Current at Any Pin (Note 14)	5 mA
Package Input Current (Note 14)	20 mA
Power Dissipation (Note 15)	500 mW

Storage Temperature	150°C
ESD Susceptibility (Note 13)	800 V
Soldering Information (10 sec.)	260°C

## Operating Ratings (Note 2)

Temperature Range	T <sub>min</sub> ≤ T <sub>A</sub> ≤ T <sub>max</sub>
MF4CN-50	0°C ≤ T <sub>A</sub> ≤ 70°C
Supply Voltage (V <sup>+</sup> -V <sup>-</sup> )	5V to 14V

## Filter Electrical Characteristics

The following specifications apply for f<sub>CLK</sub> ≤ 250 kHz (Note 5) unless otherwise specified. **Boldface limits apply for T<sub>MIN</sub> to T<sub>MAX</sub>**; all other limits T<sub>A</sub> = T<sub>J</sub> = 25°C.

Parameter	Conditions	Typical (Note 10)	Tested Limit (Note 11)	Design Limit (Note 12)	Unit
<b>V<sup>+</sup> = +5V, V<sup>-</sup> = -5V</b>					
f <sub>c</sub> , Cutoff Frequency Range (Note 3)	Min Max			0.1 20k	Hz
Supply Current	f <sub>clk</sub> = 250 kHz	2.5	3.5	<b>3.5</b>	mA
Maximum Clock Feedthrough (Peak-to-Peak)	Filter Output V <sub>in</sub> = 0V	25			mV
H <sub>0</sub> , DC Gain	R <sub>source</sub> ≤ 2 kΩ	0.0	±0.15	<b>±0.15</b>	dB
f <sub>clk</sub> /f <sub>c</sub> , Clock to Cutoff Frequency Ratio		49.96 ±0.3%	49.96 ±1%		
f <sub>clk</sub> /f <sub>c</sub> Temperature Coefficient		±15			ppm/°C
Stopband Attenuation (Min)	at 2 f <sub>c</sub>	-25.0	-24.0	<b>-24.0</b>	dB
DC Offset Voltage		-200			mV
Minimum Output Swing	R <sub>L</sub> = 10 kΩ	+4.0 -4.5	+3.5 -4.0	<b>+3.5</b> <b>-4.0</b>	V V
Output Short Circuit Current (Note 8)	Source Sink	50 1.5			mA mA
Dynamic Range (Note 4)		80			dB
Additional Magnitude Response Test Points (Note 6) f <sub>clk</sub> = 250 kHz	f = 6000 Hz		-7.57 ±0.47	<b>-7.57</b> <b>±0.47</b>	dB
	f = 4500 Hz		-1.44 ±0.12	<b>-1.44</b> <b>±0.12</b>	
	f = 3000 Hz				
	f = 2250 Hz				dB
<b>V<sup>+</sup> = +2.5V, V<sup>-</sup> = -2.5V</b>					
f <sub>c</sub> Cutoff Frequency Range (Note 3)	min max			0.1 10k	Hz
Supply Current	f <sub>clk</sub> = 250 kHz	1.5	2.25	<b>2.25</b>	mA
Maximum Clock Feedthrough (Peak-to-Peak)	Filter Output V <sub>in</sub> = 0V	15			mV
H <sub>0</sub> , DC Gain	R <sub>source</sub> ≤ 2 kΩ	0.0	±0.15	<b>±0.15</b>	dB
f <sub>clk</sub> /f <sub>c</sub> , Clock to Cutoff Frequency Ratio		50.07 ±0.3%	50.07 ±1.0%		
f <sub>CLK</sub> /f <sub>c</sub> Temperature Coefficient		±25			ppm/°C

## Filter Electrical Characteristics (Continued)

The following specifications apply for  $f_{CLK} \leq 250$  kHz (Note 5) unless otherwise specified. **Boldface limits apply for  $T_{MIN}$  to  $T_{MAX}$** ; all other limits  $T_A = T_J = 25^\circ\text{C}$ .

Parameter		Conditions	Typical (Note 10)	Tested Limit (Note 11)	Design Limit (Note 12)	Unit
<b><math>V^+ = +2.5\text{V}</math>, <math>V^- = -2.5\text{V}</math></b>						
Stopband Attenuation (Min)		at $2 f_c$	-25.0	-24.0	<b>-24.0</b>	dB
DC Offset Voltage			-150			mV
Minimum Output Swing		$R_L = 10$ k $\Omega$	+1.5 -2.2	+1.0 -1.7	<b>+1.0</b> <b>-1.7</b>	V V
Output Short Circuit Current (Note 8)	Source Sink		28			mA
			0.5			mA
Dynamic Range (Note 4)			78			dB
Additional Magnitude Response Test Points (Note 6)		$f_{clk} = 250$ kHz				dB
$(f_c = 5$ kHz)		$f = 6000$ Hz		-7.57 $\pm 0.47$	<b>-7.57</b> <b><math>\pm 0.47</math></b>	
Magnitude at		$f = 4500$ Hz		-1.46 $\pm 0.12$	<b>-1.46</b> <b><math>\pm 0.12</math></b>	dB
$(f_c = 2.5$ kHz)		$f = 3000$ Hz				dB
Magnitude		$f = 2250$ Hz				

## Logic Input-Output Characteristics

The following specifications apply for  $V^- = 0\text{V}$  (Note 7) unless otherwise specified. **Boldface limits apply for  $T_{MIN}$  to  $T_{MAX}$** ; all other limits  $T_A = T_J = 25^\circ\text{C}$ .

Parameter		Conditions	Typical (Note 10)	Tested Limit (Note 11)	Design Limit (Note 12)	Unit
<b>SCHMITT TRIGGER</b>						
$V_{T+}$ , Positive Going Threshold Voltage	Min	$V^+ = 10\text{V}$	7.0	6.1	<b>6.1</b>	V
	Max	$V^+ = 5\text{V}$	3.5	3.1 4.4	<b>3.1</b> <b>4.4</b>	V
$V_{T-}$ , Negative Going Threshold Voltage	Min	$V^+ = 10\text{V}$	3.0	1.3	<b>1.3</b>	V
	Max	$V^+ = 5\text{V}$	1.5	0.6 1.9	<b>0.6</b> <b>1.9</b>	V
Hysteresis ( $V_{T+} - V_{T-}$ )	Min	$V^+ = 10\text{V}$	4.0	2.3	<b>2.3</b>	V
	Max	$V^+ = 5\text{V}$	2.0	1.2 3.8	<b>1.2</b> <b>3.8</b>	V
Minimum Logical "1" Output Voltage (pin 2)	$I_o = -10$ $\mu\text{A}$	$V^+ = 10\text{V}$		9.0	<b>9.0</b>	V
		$V^+ = 5\text{V}$		4.5	<b>4.5</b>	V
Maximum Logical "0" Output Voltage (pin 2)	$I_o = 10$ $\mu\text{A}$	$V^+ = 10\text{V}$		1.0	<b>1.0</b>	V
		$V^+ = 5\text{V}$		0.5	<b>0.5</b>	V
Minimum Output Source Current (pin 2)	CLK R Shorted to Ground	$V^+ = 10\text{V}$	6.0	3.0	<b>3.0</b>	mA
		$V^+ = 5\text{V}$	1.5	0.75	<b>0.75</b>	mA
Maximum Output Sink Current (pin 2)	CLK R Shorted to $V^+$	$V^+ = 10\text{V}$	5.0	2.5	<b>2.5</b>	mA
		$V^+ = 5\text{V}$	1.3	0.65	<b>0.65</b>	mA

## Logic Input-Output Characteristics (Continued)

The following specifications apply for  $V^- = 0V$  (Note 7) unless otherwise specified. **Boldface limits apply for  $T_{MIN}$  to  $T_{MAX}$** ; all other limits  $T_A = T_J = 25^\circ C$ .

Parameter	Conditions	Typical (Note 10)	Tested Limit (Note 11)	Design Limit (Note 12)	Unit
<b>TTL CLOCK INPUT, CLK R PIN</b> (Note 9)					
Maximum $V_{IL}$ , Logical "0" Input Voltage		0.8			V
Minimum $V_{IH}$ , Logical "1" Input Voltage		2.0			V
Maximum Leakage Current at CLK R Pin	L. Sh Pin at Mid-Supply	2.0			$\mu A$

**Note 1:** Absolute Maximum Ratings indicate limits beyond which damage to the device may occur. AC and DC electrical specifications do not apply when operating the device beyond its specified operating conditions.

**Note 2:** All voltages are with respect to GND.

**Note 3:** The cutoff frequency of the filter is defined as the frequency where the magnitude response is 3.01 dB less than the DC gain of the filter.

**Note 4:** For  $\pm 5V$  supplies the dynamic range is referenced to 2.82 Vrms (4V peak) where the wideband noise over a 20 kHz bandwidth is typically 280  $\mu V$ rms for the MF4-50. For  $\pm 2.5V$  supplies the dynamic range is referenced to 1.06 Vrms (1.5V peak) where the wideband noise over a 20 kHz bandwidth is typically 130  $\mu V$ rms.

**Note 5:** The specifications for the MF4 have been given for a clock frequency ( $f_{CLK}$ ) of 250 kHz or less. Above the clock frequency the cutoff frequency begins to deviate from the specified error band of  $\pm 0.6\%$  but the filter still maintains its magnitude characteristics. See Application Hints.

**Note 6:** Besides checking the cutoff frequency ( $f_c$ ) and the stopband attenuation at  $2f_c$ , two additional frequencies are used to check the magnitude response of the filter. The magnitudes are referenced to a DC gain of 0.0 dB.

**Note 7:** For simplicity all the logic levels have been referenced to  $V^- = 0V$  (except for the TTL input logic levels). The logic levels will scale accordingly for  $\pm 5V$  and  $\pm 2.5V$  supplies.

**Note 8:** The short circuit source current is measured by forcing the output that is being tested to its maximum positive voltage swing and then shorting that output to the negative supply. The short circuit sink current is measured by forcing the output that is being tested to its maximum negative voltage and then shorting that output to the positive supply. These are worst case conditions.

**Note 9:** The MF4 is operating with symmetrical split supplies and L. Sh is tied to ground.

**Note 10:** Typicals are at  $25^\circ C$  and represent most likely parametric norm.

**Note 11:** Guaranteed to National's Average Outgoing Quality Level (AOQL).

**Note 12:** Guaranteed, but not 100% production tested. These limits are not used to determine outgoing quality levels.

**Note 13:** Human body model; 100 pF discharged through a 1.5 k $\Omega$  resistor.

**Note 14:** When the input voltage ( $V_{IN}$ ) at any pin exceeds the power supply rails ( $V_{IN} < V^-$  or  $V_{IN} > V^+$ ) the absolute value of current at that pin should be limited to 5 mA or less. The 20 mA package input current limits the number of pins that can exceed the power supply boundaries with a 5 mA current limit to four.

**Note 15:** Thermal Resistance

$\theta_{JA}$  (Junction to Ambient) N Package: 105 $^\circ C/W$ .

# Typical Performance Characteristics

**Power Supply Current vs Power Supply Voltage**

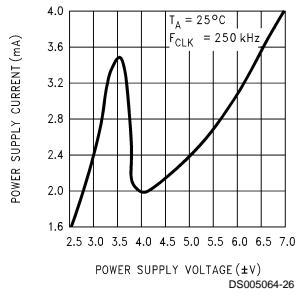

**Power Supply Current vs Clock Frequency**

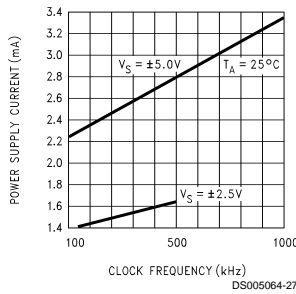

**Power Supply Current vs Temperature**

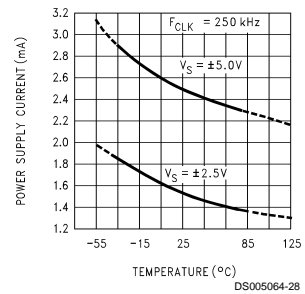

**Positive Voltage Swing vs Power Supply Voltage**

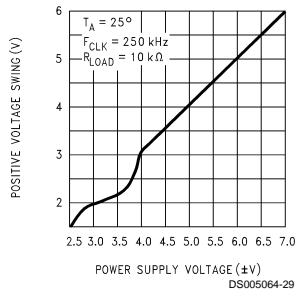

**Negative Voltage Swing vs Power Supply Voltage**

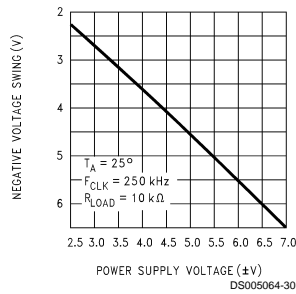

**Positive Voltage Swing vs Temperature**

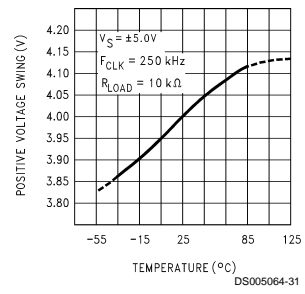

**Negative Voltage Swing vs Temperature**

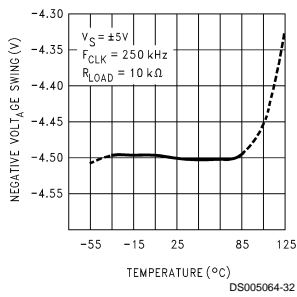

**f<sub>CLK</sub>/f<sub>c</sub> Deviation vs Power Supply Voltage**

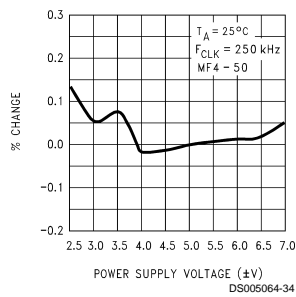

**f<sub>CLK</sub>/f<sub>c</sub> Deviation vs Clock Frequency**

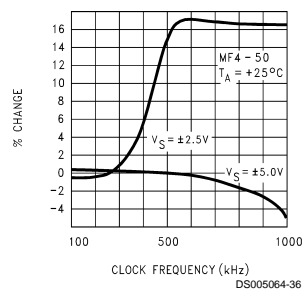

## Typical Performance Characteristics (Continued)

**$f_{CLK}/f_c$  Deviation vs Temperature**

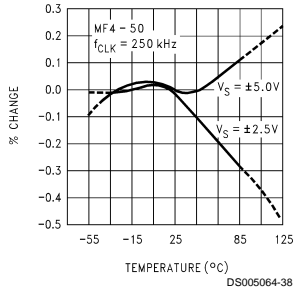

**DC Gain Deviation vs Power Supply Voltage**

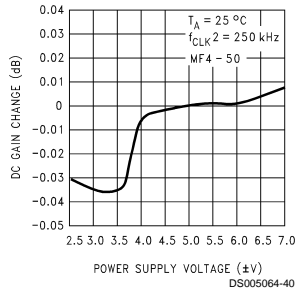

**DC Gain Deviation vs Temperature**

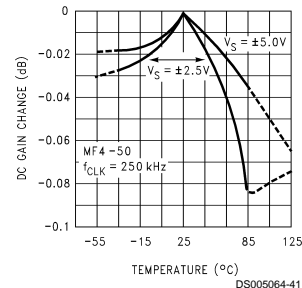

### 1.0 MF4 Application Hints

The MF4 is a non-inverting unity gain low-pass fourth-order Butterworth switched-capacitor filter. The switched-capacitor topology makes the cutoff frequency (where the gain drops 3.01 dB below the DC gain) a direct ratio of the clock frequency supplied to the filter. Internal integrator time constants set the filter's cutoff frequency. The resistive element of these integrators is actually a capacitor which is "switched" at the clock frequency (for a detailed discussion see Input Impedance Section). Varying the clock frequency changes the value of this resistive element and thus the time constant of the integrators. The clock-to-cutoff-frequency ratio ( $f_{CLK}/f_c$ ) is set by the ratio of the input and feedback capacitors in the integrators. The higher the clock-to-cutoff-frequency ratio the closer this approximation is to the theoretical Butterworth response. The MF4 is available in  $f_{CLK}/f_c$  ratios of 50:1 (MF4-50).

#### 1.1 CLOCK INPUTS

The MF4 has a Schmitt-trigger inverting buffer which can be used to construct a simple R/C oscillator. Pin 3 is connected to  $V^-$  which makes Pin 2 a low impedance output. The oscillator's frequency is nominally

$$f_{CLK} = \frac{1}{RC \ln \left[ \left( \frac{V_{CC} - V_{T-}}{V_{CC} - V_{T+}} \right) \left( \frac{V_{T+}}{V_{T-}} \right) \right]} \quad (1)$$

which, is typically

$$f_{CLK} \approx \frac{1}{1.69 RC} \quad (2)$$

for  $V_{CC} = 10V$ .

Note that  $f_{CLK}$  is dependent on the buffer's threshold levels as well as the resistor/capacitor tolerance (see Figure 1). Schmitt-trigger threshold voltage levels can change significantly causing the R/C oscillator's frequency to vary greatly from part to part.

Where accurate cutoff frequency is required, an external clock can be used to drive the CLK R input of the MF4. This input is TTL logic level compatible and also presents a very light load to the external clock source ( $\sim 2 \mu A$ ). With split supplies and the level shift (L. Sh) tied to system ground, the logic level is about 2V. (See the Pin Description for L. Sh).

#### 1.2 POWER SUPPLY

The MF4 can be powered from a single supply or split supplies. The split supply mode shown in Figures 2, 3 is the most flexible and easiest to implement. Supply voltages of  $\pm 5V$  to  $\pm 7V$  enable the use of TTL or CMOS clock logic levels. Figure 4 shows AGND resistor-biased to  $V^+/2$  for single supply operation. In this mode only CMOS clock logic levels can be used, and input signals should be capacitor-coupled or biased near mid-supply.

#### 1.3 INPUT IMPEDANCE

The MF4 low-pass filter input (FILTER IN) is not a high impedance buffer input. This input is a switched-capacitor resistor equivalent, and its effective impedance is inversely proportional to the clock frequency. The equivalent circuit of the filter's input can be seen in Figure 5. The input capacitor charges to  $V_{in}$  during the first half of the clock period; during the second half the charge is transferred to the feedback capacitor. The total transfer of charge in one clock cycle is therefore  $Q = C_{in}V_{in}$ , and since current is defined as the flow of charge per unit time, the average input current becomes

$$I_{in} = Q/T$$

(where T equals one clock period) or

$$I_{in} = \frac{C_{in}V_{in}}{T} = C_{in}V_{in}f_{CLK}$$

The equivalent input resistor ( $R_{in}$ ) then can be expressed as

$$R_{in} = \frac{V_{in}}{I_{in}} = \frac{1}{C_{in}f_{CLK}}$$

The input capacitor is 2 pF, so

$$R_{in} = \frac{5 \times 10^{11}}{f_{CLK}} = \frac{5 \times 10^{11}}{f_c \times 50} = \frac{1 \times 10^{10}}{f_c}$$

The higher the clock-to-cutoff-frequency ratio, the greater equivalent input resistance for a given clock frequency.

This input resistance will form a voltage divider with the source impedance ( $R_{source}$ ). Since  $R_{in}$  is inversely proportional to the cutoff frequency, operation at higher cutoff frequencies will be more likely to load the input signal which would appear as an overall decrease in gain to the output of the filter. Since the filter's ideal gain is unity, the overall gain is given by:

## 1.0 MF4 Application Hints (Continued)

$$A_v = \frac{R_{in}}{R_{in} + R_{source}}$$

If the MF were set up for a cutoff frequency of 10 kHz the input impedance would be:

$$R_{in} = \frac{1 \times 10^{10}}{10 \text{ kHz}} = 1 \text{ M}\Omega$$

In this example with a source impedance of 10K the overall gain, if the MF4 had an ideal gain of 1 or 0 dB, would be:

$$A_v = \frac{1 \text{ M}\Omega}{10 \text{ k}\Omega + 1 \text{ M}\Omega} = 0.99009 \text{ or } -0.086 \text{ dB}$$

Since the maximum overall gain error for the MF4 is  $\pm 0.15$  dB with  $R_s \leq 2 \text{ k}\Omega$  the actual gain error for this case would be +0.06 dB to -0.24 dB.

### 1.4 CUTOFF FREQUENCY RANGE

The filter's cutoff frequency ( $f_c$ ) has a lower limit due to leakage currents through the internal switches draining the charge stored on the capacitors. At lower clock frequencies these leakage currents can cause millivolts of error, for example:

$$f_{CLK} = 100 \text{ Hz}, I_{leakage} = 1 \text{ pA}, C = 1 \text{ pF}$$

$$V = \frac{1 \text{ pA}}{1 \text{ pF} (100 \text{ Hz})} = 10 \text{ mV}$$

The propagation delay in the logic and the settling time required to acquire a new voltage level on the capacitors limit the filter's accuracy at high clock frequencies. The amplitude characteristic on  $\pm 5V$  supplies will typically stay flat until  $f_{CLK}$  exceeds 750 kHz and then peak at about 0.5 dB at the corner frequency with a 1 MHz clock. As supply voltage drops to  $\pm 2.5V$ , a shift in the  $f_{CLK}/f_c$  ratio occurs which will become noticeable when the clock frequency exceeds 250 kHz. The response of the MF4 is still a good approximation of the ideal Butterworth low-pass characteristic shown in Figures 6, 7.

## 2.0 Designing With The MF4

Given any low-pass filter specification, two equations will come in handy in trying to determine whether the MF4 will do the job. The first equation determines the order of the low-pass filter required to meet a given response specification:

$$n = \frac{\log [(10^{0.1A_{min}} - 1)/(10^{0.1A_{max}} - 1)]}{2 \log (f_s/f_b)} \quad (3)$$

where  $n$  is the order of the filter,  $A_{min}$  is the minimum stopband attenuation (in dB) desired at frequency  $f_s$ , and  $A_{max}$  is the passband ripple or attenuation (in dB) at cutoff frequency  $f_b$ . If the result of this equation is greater than 4, more than a single MF4 is required.

The attenuation at any frequency can be found by the following equation:

$$\text{Attn} (f) = 10 \log [1 + (10^{0.1A_{max}} - 1) (f/f_b)^{2n}] \text{ dB} \quad (4)$$

where  $n = 4$  for the MF4.

## 2.1 A LOW-PASS DESIGN EXAMPLE

Suppose the amplitude response specification in Figure 8 is given. Can the MF4 be used? The order of the Butterworth approximation will have to be determined using Equation (1):

$$A_{min} = 18 \text{ dB}, A_{max} = 1.0 \text{ dB}, f_s = 2 \text{ kHz}, \text{ and } f_b = 1 \text{ kHz}$$

$$n = \frac{\log [(10^{1.8} - 1)/(10^{0.1} - 1)]}{2 \log(2)} = 3.95$$

Since  $n$  can only take on integer values,  $n = 4$ . Therefore the MF4 can be used. In general, if  $n$  is 4 or less a single MF4 stage can be utilized.

Likewise, the attenuation at  $f_s$  can be found using Equation (4) with the above values and  $n = 4$ :

$$\text{Attn} (2 \text{ kHz}) = 10 \log [1 + 10^{0.1} - 1) (2 \text{ kHz}/1 \text{ kHz})^8] = 18.28 \text{ dB}$$

This result also meets the design specification given in Figure 8 again verifying that a single MF4 section will be adequate.

Since the MF4's cutoff frequency ( $f_c$ ), which corresponds to a gain attenuation of -3.01 dB, was not specified in this example, it needs to be calculated. Solving Equation (4) where  $f = f_c$  as follows:

$$f_c = f_b \left[ \frac{(10^{0.1(3.01 \text{ dB})} - 1)}{(10^{0.1A_{max}} - 1)} \right]^{1/(2n)}$$

$$= 1 \text{ kHz} \left[ \frac{10^{0.301} - 1}{10^{0.1} - 1} \right]^{1/8}$$

$$= 1.184 \text{ kHz}$$

where  $f_c = f_{CLK}/50$ . To implement this example for the MF4-50 the clock frequency will have to be set to  $f_{CLK} = 50(1.184 \text{ kHz}) = 59.2 \text{ kHz}$ , or for the MF4-100,  $f_{CLK} = 100(1.184 \text{ kHz}) = 118.4 \text{ kHz}$ .

## 2.2 CASCADING MF4s

When a steeper stopband attenuation rate is required, two MF4s can be cascaded (Figure 9) yielding an 8th order slope of 48 dB per octave. Because the MF4 is a Butterworth filter and therefore has no ripple in its passband when MF4s are cascaded, the resulting filter also has no ripple in its passband. Likewise the DC and passband gains will remain at  $1V/V$ . The resulting response is shown in Figure 10, Figure 11.

In determining whether the cascaded MF4s will yield a filter that will meet a particular amplitude response specification, as above, Equations (5), (6) can be used, shown below.

$$n = \frac{\log [(10^{0.05A_{min}} - 1)/(10^{0.05A_{max}} - 1)]}{2 \log (f_s/f_c)} \quad (5)$$

$$\text{Attn} (f) = 10 \log [1 + (10^{0.05A_{max}} - 1) (f/f_c)^2] \text{ dB} \quad (6)$$

where  $n = 4$  (the order of each filter).

Equation (5) will determine whether the order of the filter is adequate ( $n \leq 4$ ) while Equation (6) can determine the actual stopband attenuation and cutoff frequency ( $f_c$ ) necessary to obtain the desired frequency response. The design procedure would be identical to the one shown in section 2.0.



## 2.0 Designing With The MF4

(Continued)

### 2.3 CHANGING CLOCK FREQUENCY INSTANTANEOUSLY

The MF4 will respond favorably to an instantaneous change in clock frequency. If the control signal in *Figure 12* is low the MF4-50 has a 100 kHz clock making  $f_c = 2$  kHz; when this signal goes high the clock frequency changes to 50 kHz yielding  $f_c = 1$  kHz. As the Figure illustrates, the output signal changes quickly and smoothly in response to a sudden change in clock frequency.

The step response of the MF4 in *Figure 13* is dependent on  $f_c$ . The MF4 responds as a classical fourth-order Butterworth low-pass filter.

### 2.4 ALIASING CONSIDERATIONS

Aliasing effects have to be considered when input signal frequencies exceed half the sampling rate. For the MF4 this equals half the clock frequency ( $f_{CLK}$ ). When the input signal contains a component at a frequency higher than half the clock frequency  $f_{CLK}/2$ , as in *Figure 14a*, that component will be "reflected" about  $f_{CLK}/2$  into the frequency range below  $f_{CLK}/2$ , as in *Figure 14b*. If this component is within the pass-band of the filter and of large enough amplitude it can cause problems. Therefore, if frequency components in the input signal exceed  $f_{CLK}/2$  they must be attenuated before being applied to the MF4 input. The necessary amount of attenuation will vary depending on system requirements. In critical applications the signal components above  $f_{CLK}/2$  will have to be attenuated at least to the filter's residual noise level.

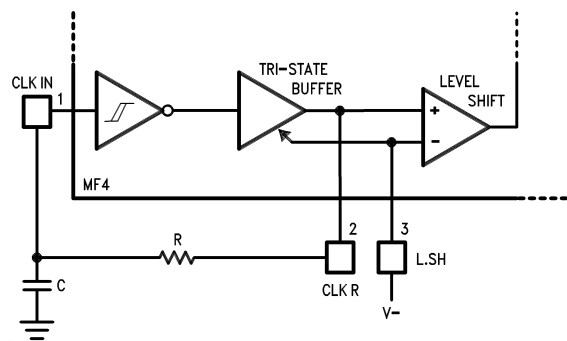

DS005064-11

$$f = \frac{1}{RC \ln \left[ \left( \frac{V_{CC} - V_{T-}}{V_{CC} - V_{T+}} \right) \left( \frac{V_{T+}}{V_{T-}} \right) \right]}$$

$$f \approx \frac{1}{1.69 RC}$$

( $V_{CC} = 10V$ )

FIGURE 1. Schmitt Trigger R/C Oscillator

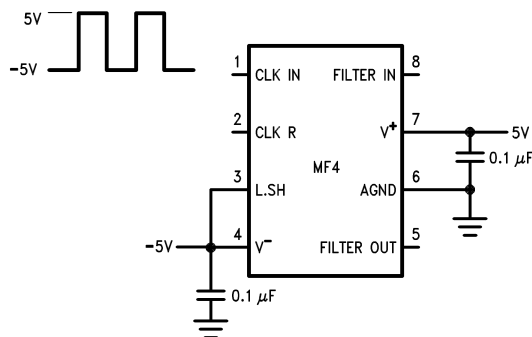

DS005064-12

$$V_{IH} \geq 0.8 V_{CC}$$

$$V_{IL} \leq 0.2 V_{CC}$$

$$V_{CC} = V^+ - V^-$$

FIGURE 2. Split Supply Operation with CMOS Level Clock

## 2.0 Designing With The MF4 (Continued)

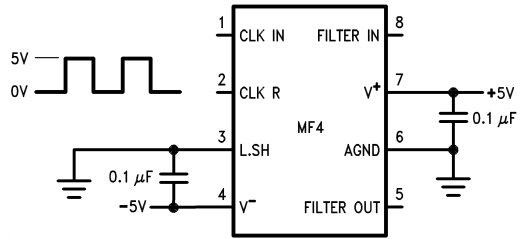

DS005064-13

FIGURE 3. Split Supply Operation with TTL Level Clock

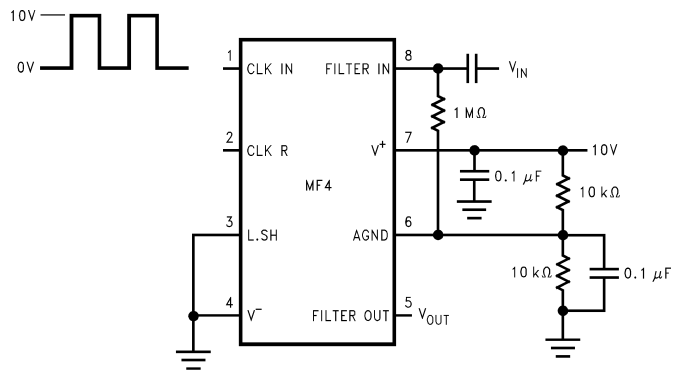

DS005064-14

FIGURE 4. Single Supply Operation. ANGD Resistor Biased to  $V^+/2$

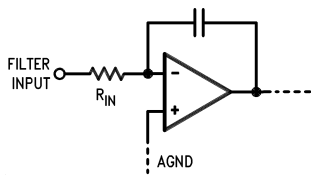

DS005064-15

a) Equivalent Circuit for MF4 Filter Input

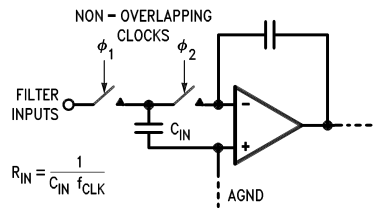

DS005064-20

b) Actual Circuit for MF4 Filter Input

FIGURE 5. MF4 Filter Input

## 2.0 Designing With The MF4 (Continued)

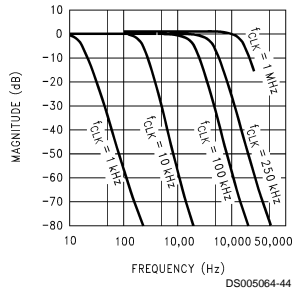

FIGURE 6. MF4-50 Amplitude Response with  $\pm 5V$  Supplies

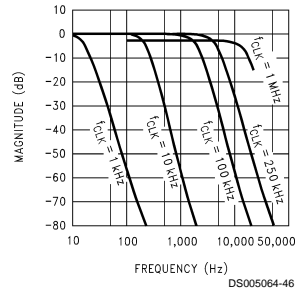

FIGURE 7. MF4-50 Amplitude Response with  $\pm 2.5V$  Supplies

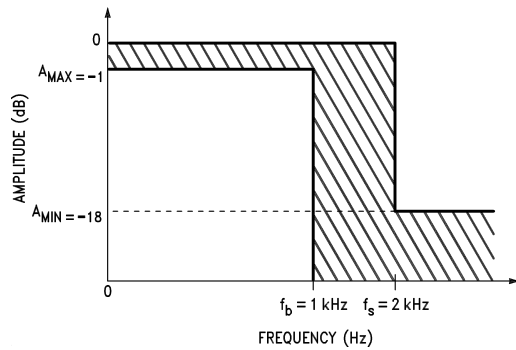

FIGURE 8. Design Example Magnitude Response Specification where the Response of the Filter Design must fall within the shaded area of the specification

## 2.0 Designing With The MF4 (Continued)

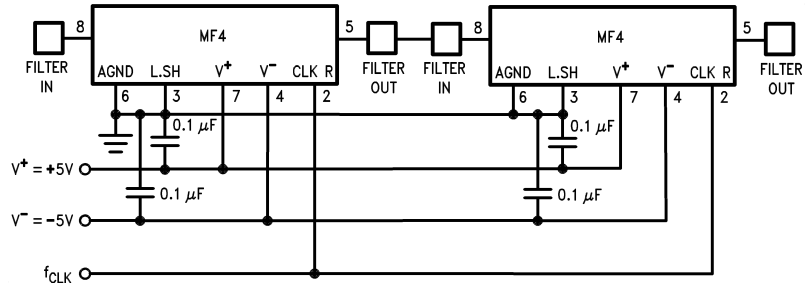

FIGURE 9. Cascading Two MF4s

DS005064-23

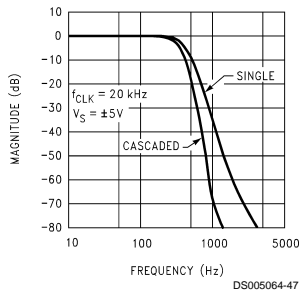

FIGURE 10. One MF4-50 vs Two MF4-50s Cascaded

DS005064-47

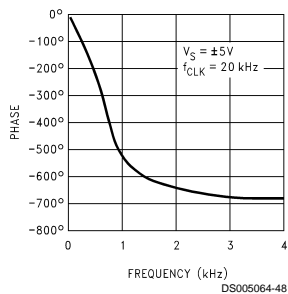

FIGURE 11. Phase Response of Two Cascaded MF4-50s

DS005064-48

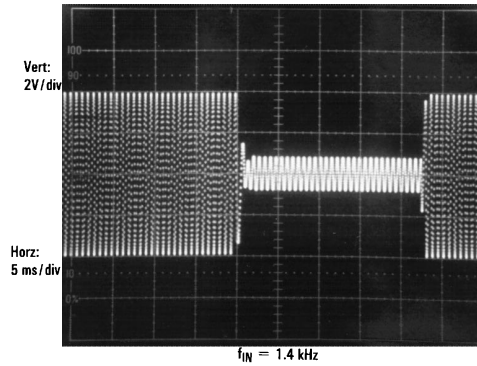

FIGURE 12. MF4-50 Abrupt Clock Frequency Change

DS005064-24

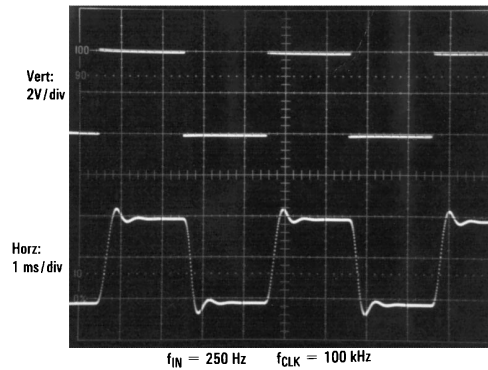
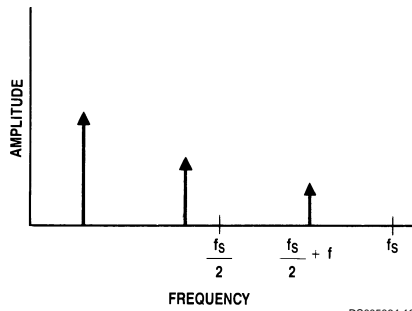

FIGURE 13. MF4-50 Input Step Response

DS005064-19

## 2.0 Designing With The MF4 (Continued)



DS005064-16

(a) input signal spectrum

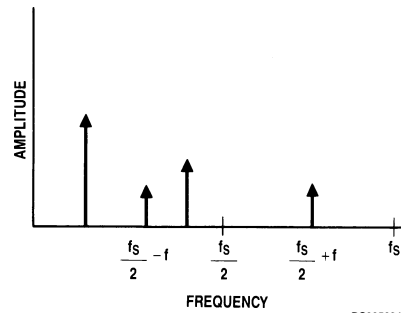

DS005064-17

(b) Output signal spectrum. Note that the input signal at  $f_c/2 + f$  causes an output signal to appear at  $f_c/2 - f$ .

**FIGURE 14.** The phenomenon of aliasing in sampled-data systems. An input signal whose frequency is greater than one-half the sampling frequency will cause an output to appear at a frequency lower than one-half the sampling frequency. In the MF4,  $f_s = f_{CLK}$ .

**Physical Dimensions** inches (millimeters) unless otherwise noted

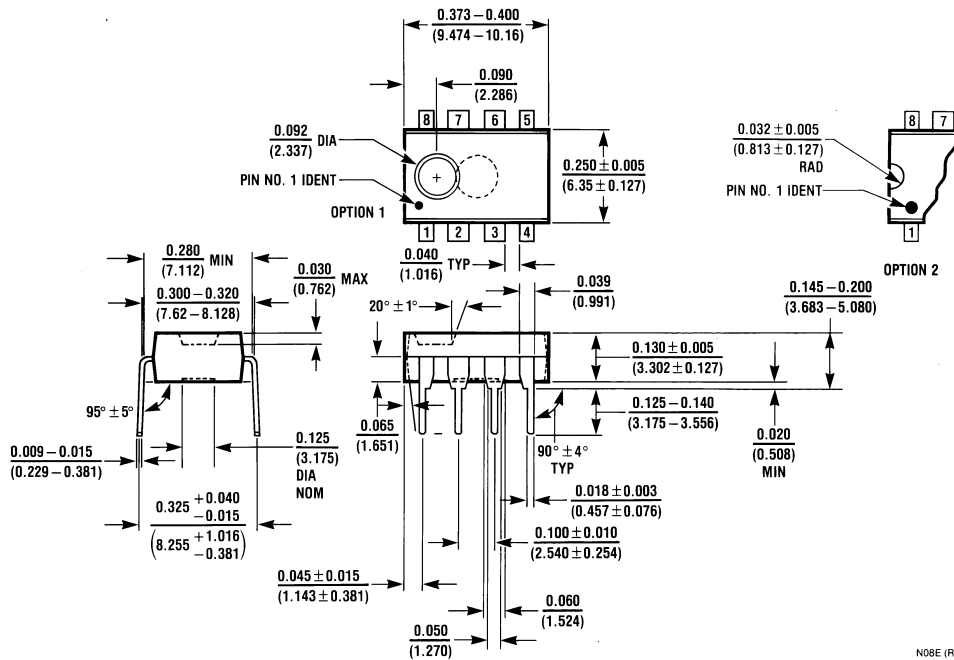

**Molded Dual-In-Line Package (N)**  
**Order Number MF4CN-50**  
**NS Package Number N08E**

N08E (REV F)

**LIFE SUPPORT POLICY**

NATIONAL'S PRODUCTS ARE NOT AUTHORIZED FOR USE AS CRITICAL COMPONENTS IN LIFE SUPPORT DEVICES OR SYSTEMS WITHOUT THE EXPRESS WRITTEN APPROVAL OF THE PRESIDENT AND GENERAL COUNSEL OF NATIONAL SEMICONDUCTOR CORPORATION. As used herein:

1. Life support devices or systems are devices or systems which, (a) are intended for surgical implant into the body, or (b) support or sustain life, and whose failure to perform when properly used in accordance with instructions for use provided in the labeling, can be reasonably expected to result in a significant injury to the user.
2. A critical component is any component of a life support device or system whose failure to perform can be reasonably expected to cause the failure of the life support device or system, or to affect its safety or effectiveness.



**National Semiconductor Corporation**  
 Americas  
 Tel: 1-800-272-9959  
 Fax: 1-800-737-7018  
 Email: support@nsc.com

**National Semiconductor Europe**  
 Fax: +49 (0) 1 80-530 85 86  
 Email: europe.support@nsc.com  
 Deutsch Tel: +49 (0) 1 80-530 85 85  
 English Tel: +49 (0) 1 80-532 78 32  
 Français Tel: +49 (0) 1 80-532 93 58  
 Italiano Tel: +49 (0) 1 80-534 16 80

**National Semiconductor Asia Pacific Customer Response Group**  
 Tel: 65-2544466  
 Fax: 65-2504466  
 Email: sea.support@nsc.com

**National Semiconductor Japan Ltd.**  
 Tel: 81-3-5639-7560  
 Fax: 81-3-5639-7507

www.national.com