

T-31-25
BF 960

N-Channel Dual Gate MOS-Fieldeffect Tetrode · Depletion Mode

Applications: Input- and Mixerstages especially for UHF TV-tuners up to 900 MHz

Features:

- Integrated Gate protection diodes
- High cross modulation performance
- Low noise figure
- High AGC-range
- Low feedback capacitance
- Low input capacitance

Dimensions in mm

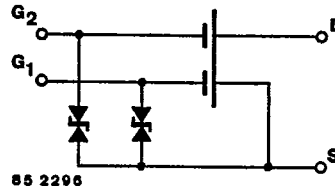
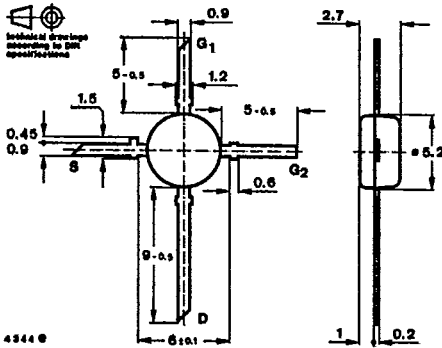

Case
50 B 4 DIN 41 867
JEDEC TO 50
Weight max. 0.1 g

Absolute maximum ratings

Drain Source Voltage	V_{DS}	20	V
Drain current	I_D	30	mA
Gate 1/Gate 2-Source peak current	$\pm I_{G1/2SM}$	10	mA
Total power dissipation $T_{amb} = 60^\circ C$	P_{tot}	200	mW
Channel temperature	T_C	150	$^\circ C$
Storage temperature range	T_{stg}	-55 ... +150	$^\circ C$

Thermal resistance

	Min.	Typ.	Max.
Channel ambient mounted on pc-board one side Cu 35 μm thickness 40 x 25 x 1.5 mm ³			450 K/W

T1.2/330.1183 E2

3523 6-04

BF 960

T-31-25

DC characteristics

Min. Typ. Max.

$T_{amb} = 25\text{ }^\circ\text{C}$, unless otherwise specified

Drain-source breakdown voltage

$I_D = 10\text{ }\mu\text{A}$, $-V_{G1S} = -V_{G2S} = 4\text{ V}$ $V_{(BR)DS}$ 20 V

Gate 1-Source breakdown voltage

$\pm I_{G1S} = 10\text{ mA}$, $V_{G2S} = V_{DS} = 0$ $\pm V_{(BR)G1SS}$ 6 20 V

Gate 2-Source breakdown voltage

$\pm I_{G2S} = 10\text{ mA}$, $V_{G1S} = V_{DS} = 0$ $\pm V_{(BR)G2SS}$ 6 20 V

Gate 1-Source cut-off current

$\pm V_{G1S} = 5\text{ V}$, $V_{G2S} = V_{DS} = 0$ I_{G1SS} 50 nA

Gate 2-Source cut-off current

$\pm V_{G2S} = 5\text{ V}$, $V_{G1S} = V_{DS} = 0$ I_{G2SS} 50 nA

Drain current

$V_{DS} = 15\text{ V}$, $V_{G1S} = 0$, $V_{G2S} = 4\text{ V}$ I_{DSS} 2 20 mA

Gate 1-Source cut-off voltage

$V_{DS} = 15\text{ V}$, $V_{G2S} = 4\text{ V}$, $I_D = 20\text{ }\mu\text{A}$ $-V_{G1S(OFF)}$ 2.7 V

Gate 2-Source cut-off voltage

$V_{DS} = 15\text{ V}$, $V_{G1S} = 0\text{ V}$, $I_D = 20\text{ }\mu\text{A}$ $-V_{G2S(OFF)}$ 2.7 V

AC characteristics

$V_{DS} = 15\text{ V}$, $I_D = 7\text{ mA}$, $V_{G2S} = 4\text{ V}$, $f = 1\text{ MHz}$,

$T_{amb} = 25\text{ }^\circ\text{C}$, unless otherwise specified

Forward transadmittance $|y_{21}|$ 10 13 mS

Gate 1-Input capacitance C_{ISSg1} 1.8 pF

Gate 2-Input capacitance $V_{G1S} = 0$, $V_{G2S} = 4\text{ V}$ C_{ISSg2} 1.0 pF

Feedback capacitance $C_{rSS}^{1)}$ 25 fF

Output capacitance C_{oSS} 0.8 pF

Power gain

$V_{DS} = 15\text{ V}$, $I_D = 7\text{ mA}$, $V_{G2S} = 4\text{ V}$, $g_G = 2\text{ mS}$, G_{ps} 23 dB

$g_L = 5\text{ mS}$, $f = 200\text{ MHz}$ G_{ps} 16.5 dB

$g_L = 1\text{ mS}$, $f = 800\text{ MHz}$

Noise figure

$g_G = 2\text{ mS}$, $f = 800\text{ MHz}$ F 2.2 3 dB

$V_{DS} = 15\text{ V}$, $I_D = 7\text{ mA}$, $V_{G2S} = 4\text{ V}$, $V_{G1S} = 0$

¹⁾ G_2 and S grounded

T-31-25

BF 960

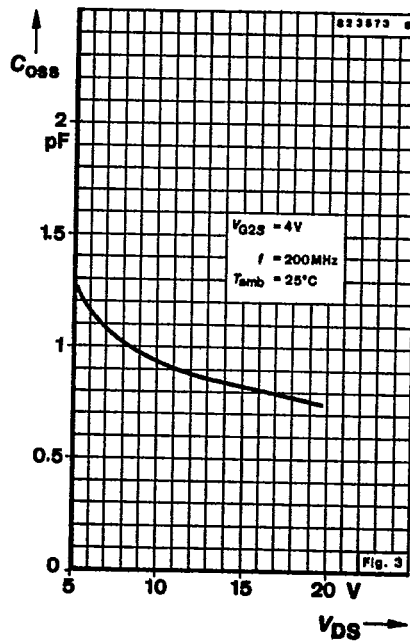
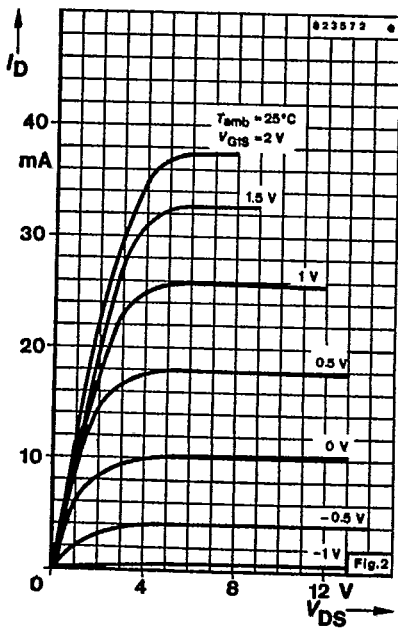
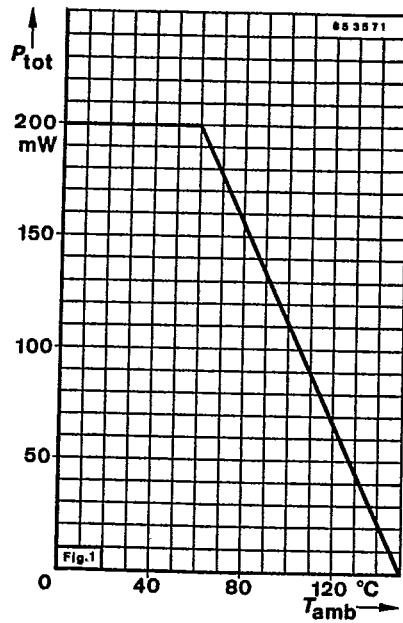

BF 960

T-31-25

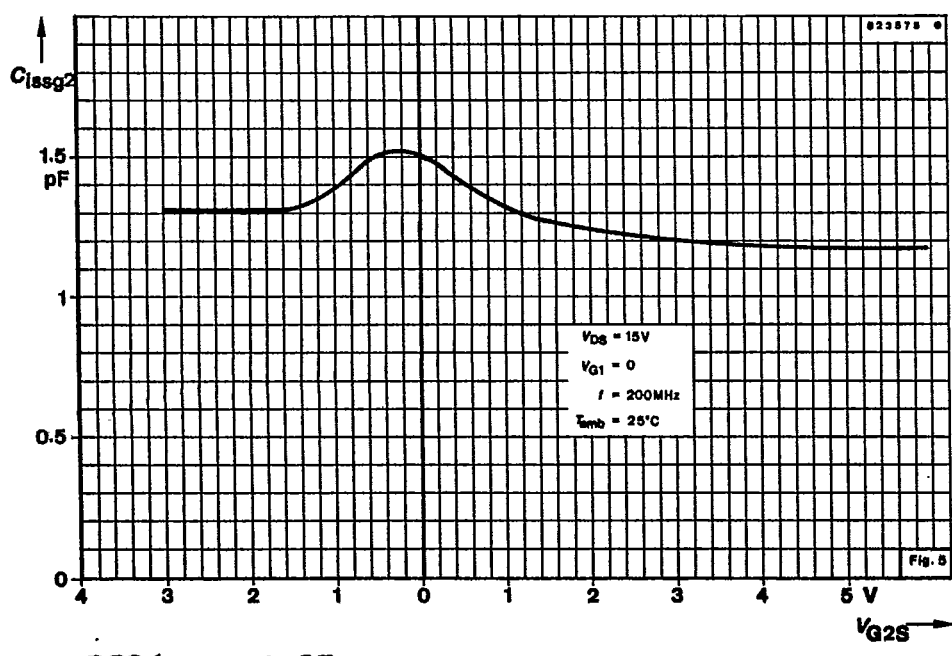
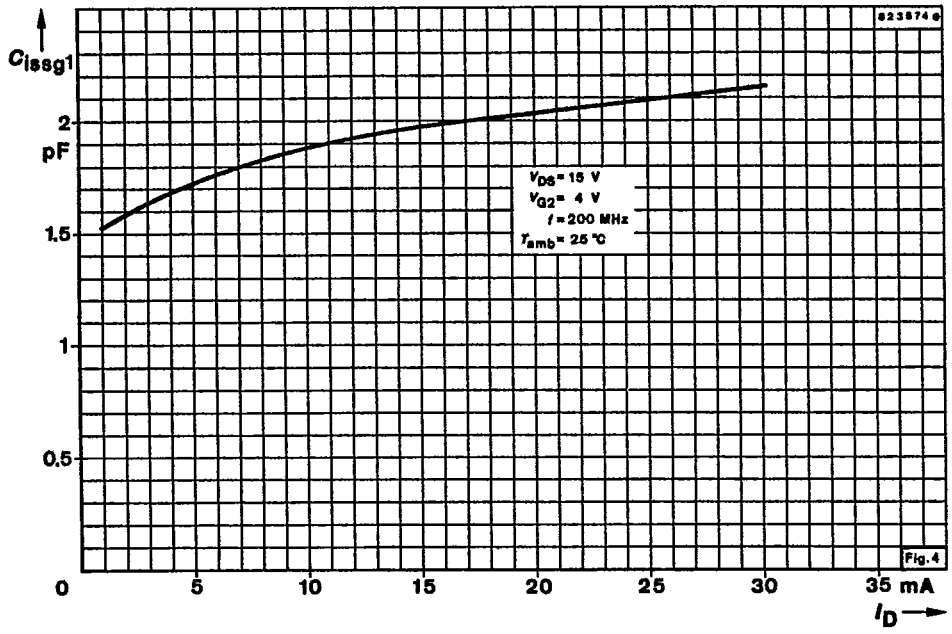

T-31-25 BF 960

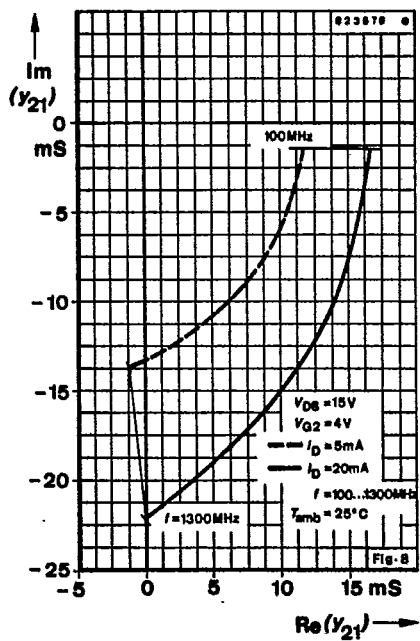
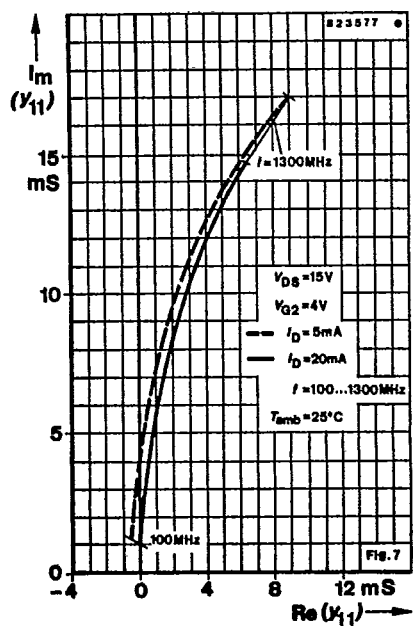
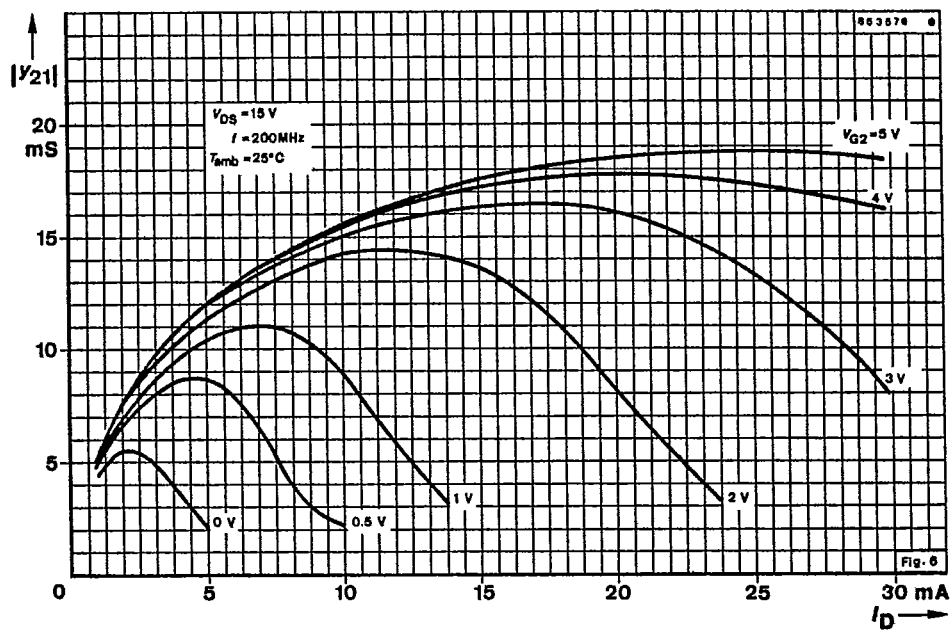

BF 960

7-31-25

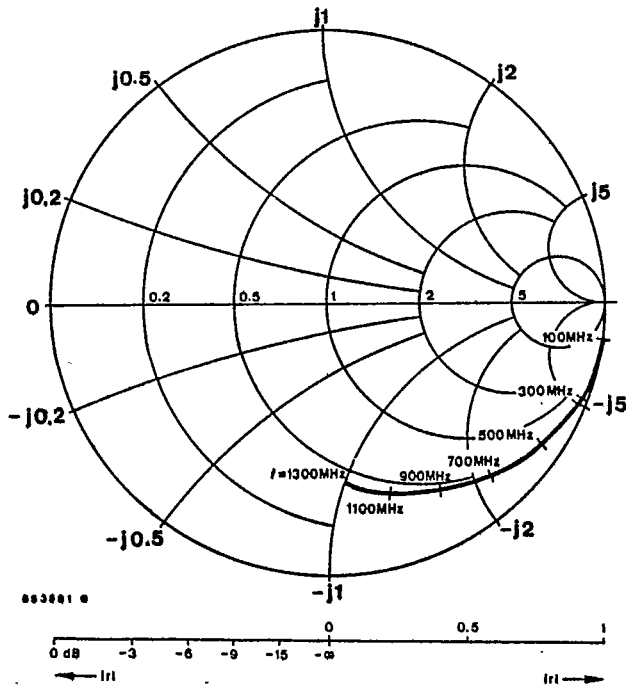
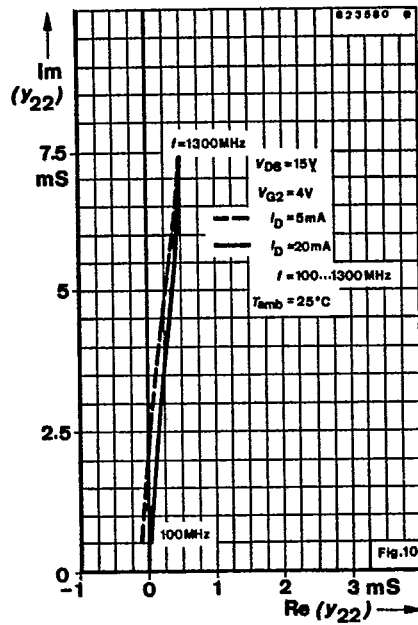
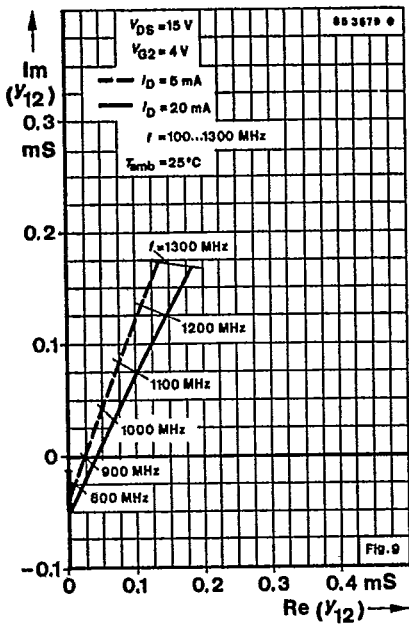

S₁₁
 $I_D = 10\text{mA}$
 $V_{DS} = 15\text{V}$
 $V_{G2} = 4\text{V}$
 $Z_0 = 50\Omega$
 $f = 100 \dots 1300\text{MHz}$
 $T_{amb} = 25^\circ\text{C}$

Fig. 11

7-31-25

BF 960

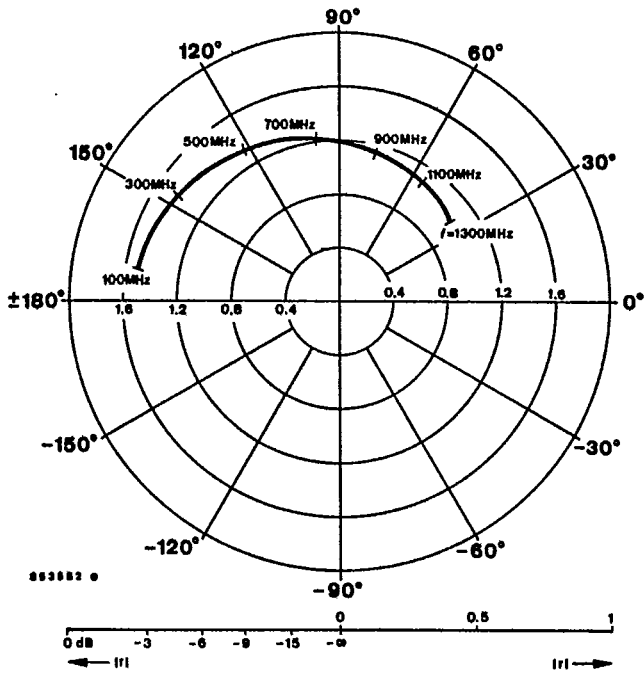

S₂₁

Z₀ = 50 Ω
 V_{DS} = 15 V
 V_{G2} = 4 V
 I_D = 10 mA
 f = 100...1300 MHz
 T_{amb} = 25 °C

Fig.12

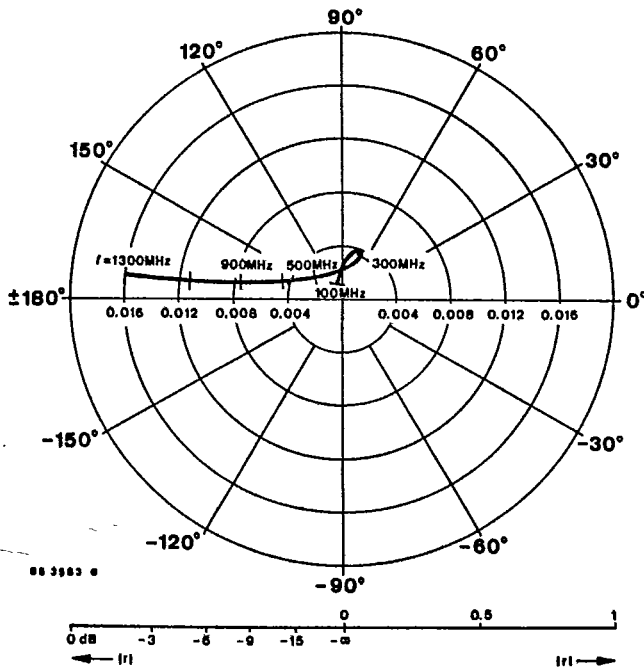

S₁₂

Z₀ = 50 Ω
 V_{DS} = 15 V
 V_{G2} = 4 V
 I_D = 10 mA
 f = 100...1300 MHz
 T_{amb} = 25 °C

Fig.13

T-31-25

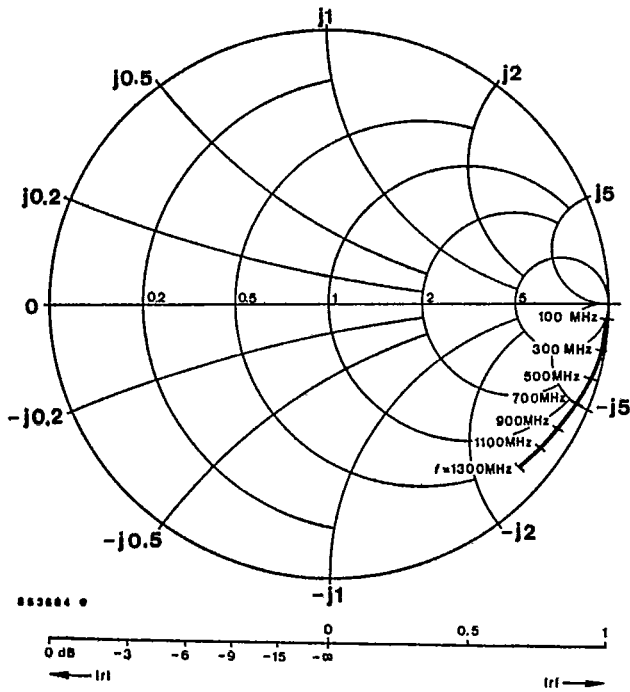

S₂₂
 $I_D = 3 \dots 10 \text{ mA}$
 $V_{DS} = 15 \text{ V}$
 $V_{G2} = 4 \text{ V}$
 $Z_0 = 50 \Omega$
 $f = 100 \dots 1300 \text{ MHz}$
 $T_{amb} = 25^\circ \text{C}$

Fig.14

7. Taping and Reeling

T-91-20

7.1. Taping of TO-92 Transistors

Standard reeling: Taped on reel, reeled together with a paper film.

7.1.1. Order Numbers

Add the taping-code to the order number.

Example:

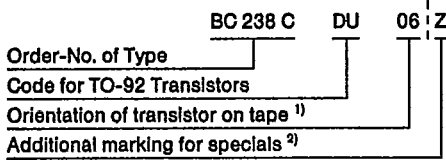

- ¹⁾ 06 = View on flat side of transistor, view on gummed tape
- 05 = View on round side of transistor, view on gummed tape

- ²⁾ Additional marking "0": taping without paper film
- Additional marking "Z": Zigzag folded tape in special box. Marking for orientation of transistor not necessary, because box can be opened on top or bottom

Example for order No.: BC 237 C DU Z

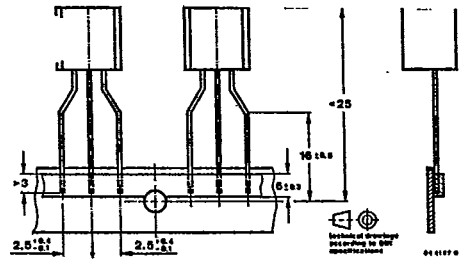

Fig. 7.3 Dimensions of tape in mm

7.1.2 Quantity of devices

- 1 000 devices per reel
- 2 000 devices per folded tape in special box.

7.2. Taped transistors in SOT 23 and SOT 143 case

7.2.1. Designation

a) Standard taping

Designation is attached with code GS 08 in case of standard taping. Example for normal version transistors as standard taped: BF 569-GS 08.

Example for R-version transistors as standard taped: BF 569 R-GS 08.

In case of standard taping, the transistor orientation on the tape is shown in Fig. 7.4 and Fig. 7.5.

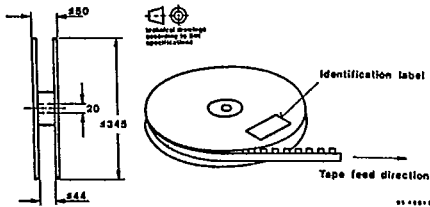

Fig. 7.1. Dimensions of reel in mm

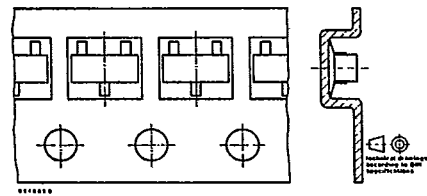

Fig. 7.4 Standard taped SOT 23

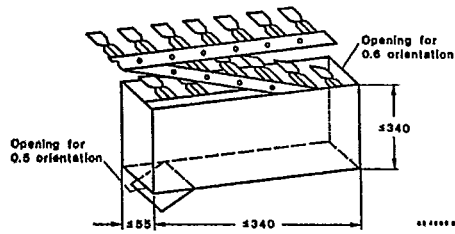

Fig. 7.2. Dimension of box for Zigzag folding in mm

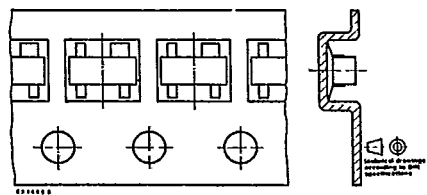

Fig. 7.5. Standard taped SOT 143

T-91-20

b) Reverse taping

Designation is attached with code GS07 in case of reverse taping. Example for normal version transistors as reverse taped: BF 569-GS 07.

Example for R-version transistors as reverse taping: BF 569 R-GS 07.

In case of reverse taping, the transistor orientation on the tape is shown in Fig. 7.6.

Regarding MOS-FET and MES-FET devices, reverse taping is at present not available.

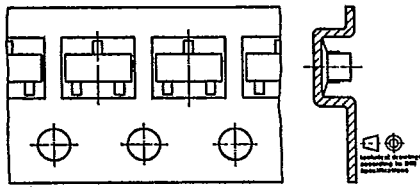

Fig. 7.6 Reverse taped SOT 23

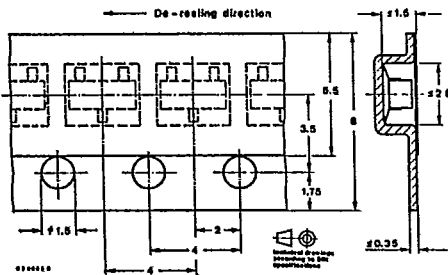

Fig. 7.7 Dimensions of tape in mm

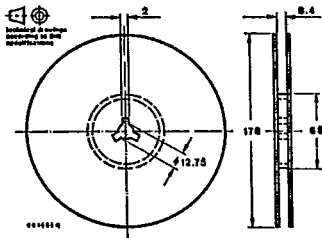

Fig. 7.8 Dimensions of reel in mm

7.2.2 Quantity of devices

3000 devices per reel