

LM317

3-Terminal Positive Adjustable Regulator

General Description

This monolithic integrated circuit is an adjustable 3-terminal positive voltage regulator designed to supply more than 1.5A of load current with an output voltage adjustable over a 1.2 to 37V. It employs internal current limiting, thermal shut-down and safe area compensation.

Features

- Output Current In Excess of 1.5A
- Output Adjustable Between 1.2V and 37V
- Internal Thermal Overload Protection
- Internal Short Circuit Current Limiting
- Output Transistor Safe Operating Area Compensation
- TO-220 Package
- D2 PAK Package

Ordering Code:

Product Number	Package	Operating Temperature
LM317T	TO-220	0°C to +125°C
LM317D2TXM	D2 PAK	0°C to +125°C

Connection Diagrams

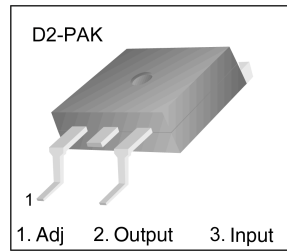
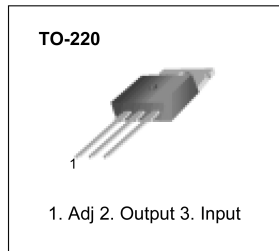

Internal Block Diagram

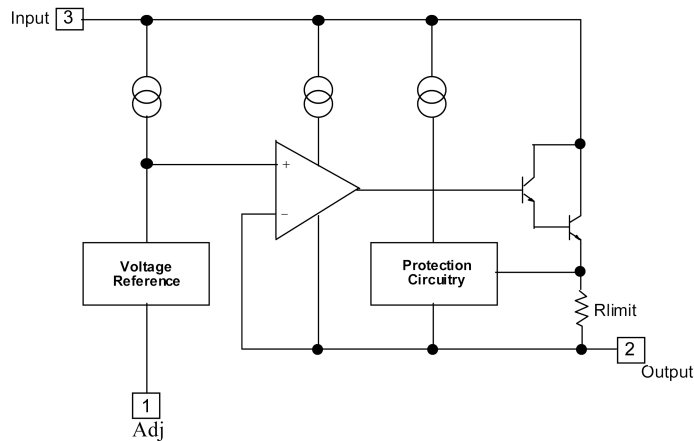

Absolute Maximum Ratings

Parameter	Symbol	Value	Unit
Input-Output Voltage Differential	$V_I - V_O$	40	V
Lead Temperature	T_{LEAD}	230	°C
Power Dissipation	P_D	Internally limited	W
Operating Junction Temperature Range	T_J	0 ~ +125	°C
Storage Temperature Range	T_{STG}	-65 ~ +125	°C
Temperature Coefficient of Output Voltage	$\Delta V_O / \Delta T$	±0.02	% / °C

Note 1: Absolute Maximum Ratings: are those values beyond which the safety of the device cannot be guaranteed. The device should not be operated at these limits. The parametric values defined in the Electrical Characteristics tables are not guaranteed at the absolute maximum ratings. The "Recommended Operating Conditions" table will define the conditions for actual device operation.

Electrical Characteristic

($V_I - V_O = 5V$, $I_O = 0.5A$, $0^\circ C \leq T_J \leq +125^\circ C$, $I_{MAX} = 1.5A$, $P_{DMAX} = 20W$, unless otherwise specified)

Parameter	Symbol	Conditions	Min	Typ	Max	Unit
Line Regulation (Note 2)	Rline	$T_A = +25^\circ C$ $3V \leq V_I - V_O \leq 40V$	—	0.01	0.04	% / V
		$3V \leq V_I - V_O \leq 40V$	—	0.02	0.07	% / V
Load Regulation (Note 2)	Rload	$T_A = +25^\circ C$, $10mA \leq I_O \leq I_{MAX}$ $V_O < 5V$ $V_O \geq 5V$	—	18.0 0.4	25.0 0.5	mV% / V_O
		$10mA \leq I_O \leq I_{MAX}$ $V_O < 5V$ $V_O \geq 5V$	—	40.0 0.8	70.0 1.5	mV% / V_O
Adjustable Pin Current	I_{ADJ}	—	—	46.0	100	μA
Adjustable Pin Current Change	ΔI_{ADJ}	$3V \leq V_I - V_O \leq 40V$ $10mA \leq I_O \leq I_{MAX}$, $P_D \leq P_{MAX}$	—	2.0	5.0	μA
Reference Voltage	V_{REF}	$3V \leq V_{IN} - V_O \leq 40V$ $10mA \leq I_O \leq I_{MAX}$ $P_D \leq P_{MAX}$	1.20	1.25	1.30	V
Temperature Stability	ST_T	—	—	0.7	—	% / V_O
Minimum Load Current to Maintain Regulation	$I_{L(MIN)}$	$V_I - V_O = 40V$	—	3.5	12.0	mA
Maximum Output Current	$I_{O(MAX)}$	$V_I - V_O \leq 15V$, $P_D \leq P_{MAX}$ $V_I - V_O \leq 40V$, $P_D \leq P_{MAX}$ $T_A = 25^\circ C$	1.0	2.2 0.3	—	A
RMS Noise, % of V_{OUT}	eN	$T_A = +25^\circ C$, $10Hz \leq f \leq 10KHz$	—	0.003	0.01	% / V_O
Ripple Rejection	RR	$V_O = 10V$, $f = 120Hz$ without C_{ADJ} $C_{ADJ} = 10\mu F$ (Note 3)	66.0	60.0 75.0	—	dB
Long-Term Stability, $T_J = T_{HIGH}$	ST	$T_A = +25^\circ C$ for end point measurements, 1000HR	—	0.3	1.0	%
Thermal Resistance Junction to Case	$R_{\theta JC}$	—	—	5.0	—	°C / W

Note 2: Load and line regulation are specified at constant junction temperature. Change in V_O due to heating effects must be taken into account separately. Pulse testing with low duty is used. ($P_{MAX} = 20S$)

Note 3: C_{ADJ} , when used, is connected between the adjustment pin and ground.

Typical Performance Characteristics

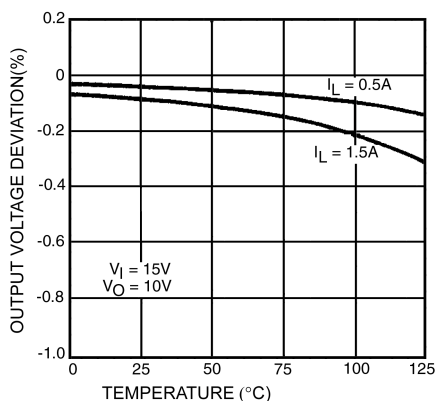

FIGURE 1. Load Regulation

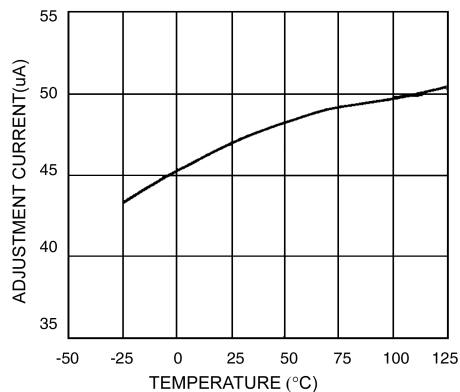

FIGURE 2. Adjustment Current

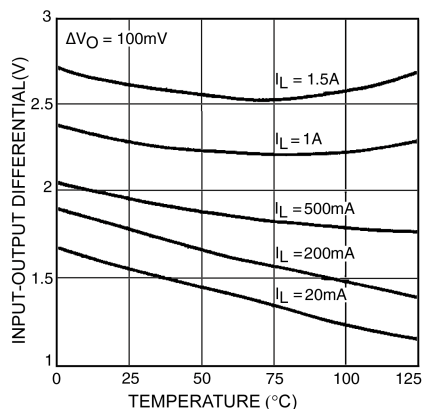

FIGURE 3. Dropout Voltage

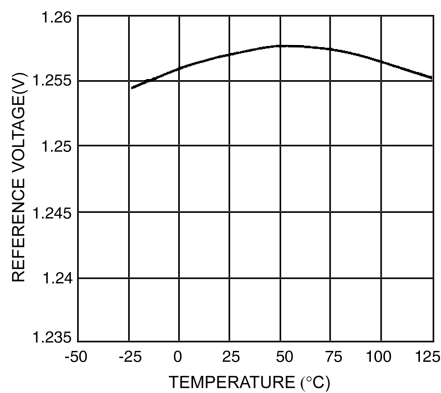
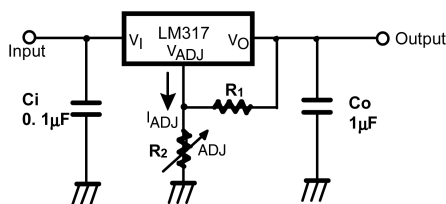

FIGURE 4. Reference Voltage

Typical Application



$$V_O = 1.25V (1 + R_2 / R_1) + I_{ADJ} R_2$$

Note: C_i is required when regulator is located an appreciable distance from power supply filter.

Note: C_o is not needed for stability, however, it does improve transient response.

Note: Since I_{ADJ} is controlled to less than 100 μA , the error associated with this term is negligible in most applications.

FIGURE 5. Programmable Regulator

Physical Dimensions inches (millimeters) unless otherwise noted

TO-220

